

DISPLAY-2056

Ovation Gazebo 2x2m - 2 Half walls - 1 Full wall

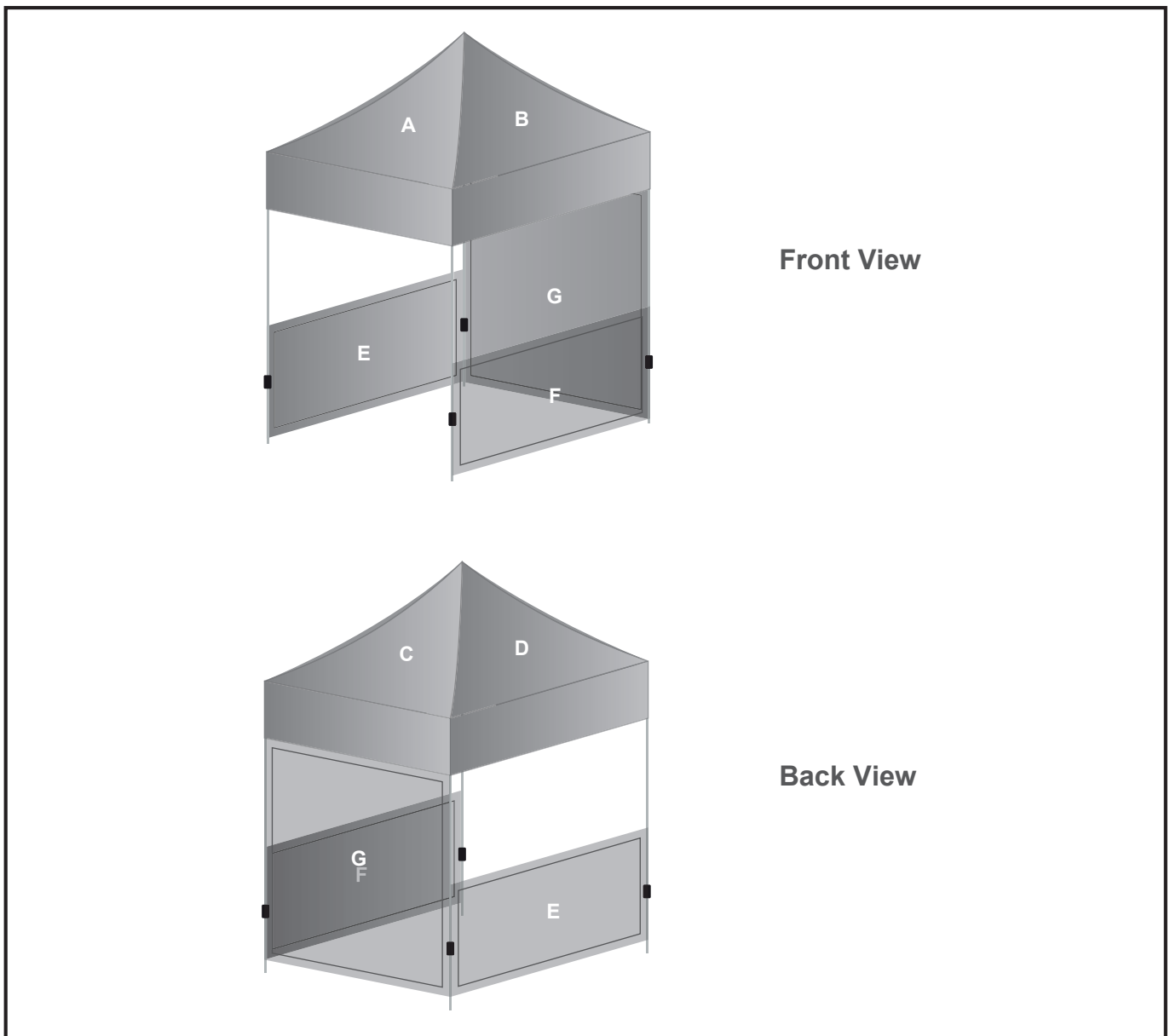

Need to know:

- Roof and walls can be printed on one side only. Printed walls can be setup to face inwards or outwards. Please see template for detailed placement.
- Acceptable file types for artwork: .pdf - minimum 100dpi at 100% - 200dpi at 50% - 400dpi at 25%
- Convert all text to curves / paths

All artwork must be created in CMYK and ALL PANTONE COLOURS must be included as a PANTONE SOLID COATED SPOT within the print file supplied. Please note failing this will result in no colour matching taking place. Please also note due to the limited colour gamut of various digital CMYK Print methods not all Pantone colours can be achieved, we endeavour to match as close as possible and colour variation will take place on different materials like PVC versus Fabric. Florescent and Metallic Pantones cannot be matched. Only a tonal representation thereof can be achieved.

Branding Options:

Position: A - B - C - D - Roof

Size: 2156mm wide x 1656mm high

Position: E - F - Half wall

Size: 2100mm wide x 1081mm high

Position: G - Full wall

Size: 2100mm wide x 2060mm high